

## Preface

After my presentation last Thursday, I realized how different my language is compared to what the CICWCD Board normally uses. For instance, Meander Scrolls are ancient channels, which channels we are mapping in Louisiana with lightning attribute maps.



Yes, I think it is possible water witches are picking up on the same shallow-earth currents which DML has demonstrated control lightning strike location. I am not aware of a way to scientifically demonstrate this, other than the obvious success some water witches, like Eldon Schmutz, have had over long periods of time.

Methane is very resistive in the subsurface, and as it seeps into the atmosphere, it becomes electrostatically charged and lowers the dielectric constant of the atmosphere (making the atmosphere more conductive). Resistivity (impedance to electric flow) and permittivity (the property of a material allowing it to store an electric charge) are electrical measurements of rocks or geologic layers, which properties DML calculates from lightning databases.

Some other terms I used, which you may not be familiar with, include: faults (breaks in layers of rock similar to a vertical crack through a stack of glass); stratigraphy (horizontal layers of sedimentary rocks); lithology (the type of rock, e.g. sandstone, limestone, clay, volcanic rock, iron ore, etc.); fluids (oil, gas, fresh water, brines, geothermal water, etc.). So I wrote these notes out for each page, hoping it helps get my message across.

Lastly, geologists explain concepts by showing examples of modern processes or examples from other places, where these examples demonstrate the concept being presented. These examples are an analog. So an analog map, is an example map pattern, which when this pattern is found elsewhere predicts similar geology.

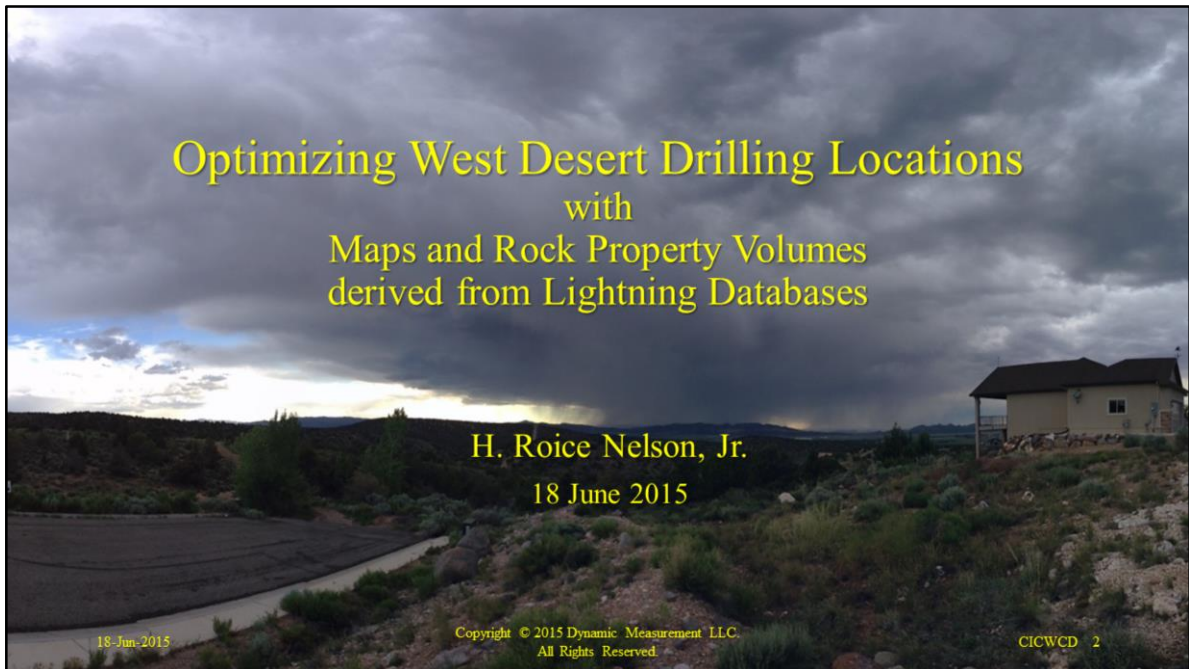

Sunday I walked out of church at the same time John Black did. There was a lightning strike and thunderclap, and John said, "Water!" I looked at John and said, "Data!" This talk is about a new geophysical data type, a new use of lightning strike data, which data has been collected since the early 1980's. The above photo shows a panorama from the west end of 700 North taken after Master's Singer's Practice Sunday evening, when I noticed yet another thunderstorm over the iron mines. Have you noticed the number of lightning strikes and thunderstorms over the iron mines compared to the rest of Cedar Valley? It is because of the magnetite at the iron mines. The number of strikes in this part of Cedar Valley is due to the geologic impact (shallow earth currents controlled by geology) on where lightning strikes the ground. DML (Dynamic Measurement LLC) is a company I started and control, which maps geology based on a large existing lightning strike databases. Scientifically, I know the CICWCD can optimize the West Desert drilling locations in Pine Valley and Wah Wah Valley using maps and rock property volumes derived from this lightning strike database.

Lightning recorded for early storm warning, safety, **insurance**, and meteorological purposes

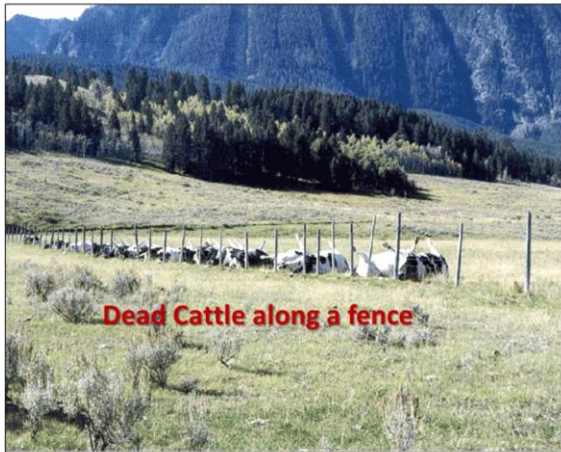

18-Jun-2015

Copyright © 2015 Dynamic Measurement LLC.  
All Rights Reserved.

CICWCD 3

Dr. Richard Orville, a meteorology professor, collected the first lightning strike location data at State University of New York in Albany in March 1982. Over the next 5 years this work expanded to become the National Lightning Detection Network (NLDN).

Insurance companies were the first commercial group to be interested in this research. Dr. Orville told us in the early 1980's 65% of houses claimed to have been burned down by lightning strikes were fraudulent or misrepresented. Insurance companies largely funded the development of the NLDN. Airports and golf courses (safety) and television weathermen (meteorology), like DML Co-Founder and Chief Meteorologist at Fox News Houston - Dr. Jim Siebert - on the right side of the slide, are the main purchasers of lightning strike location data from the privately owned NLDN.

Geophysicists, like myself, have been using telluric current (deep earth current) measurements since the 1950's to map geology. Because lightning database technology was developed in academia by meteorologists, it was missed as a source of geophysical data by oil & gas and mineral exploration geophysicists, at least until we recognized the opportunity in 2007.

## Lightning Strikes Cluster in Time and Space



The fact lightning strikes are related to geology is a new discovery. Lightning itself is a meteorological event. There are a lot more lightning strikes between the Rocky Mountains and the Appalachian Mountains where cold air from Canada flows down from the north. Locally lightning strikes cluster, and these clusters are somewhat consistent across time. The reason the lightning strikes cluster is because of terralevis (shallow earth) currents, which are controlled by electricity flowing through shallow geology. Lightning strikes will go cloud to cloud up to 150 miles. Where the strike comes to the ground is controlled by where the terralevis currents build up enough to connect with atmospheric currents. This current build-up occurs along faults, against resistive salt domes, across conductive mineral deposits, like the magnetite at the iron mine, etc.

The most strikes in the U.S. occur in Florida, where storms build up on both sides of the peninsula and come ashore each afternoon. DML found there are zero lightning strikes at high lunar tide for 15 years. The shallow carbonate layers are so porous water levels in wells goes up and down with lunar tides. Our working hypothesis in Florida is the biogenic gases generated in the swamps are all washed out of the formations by water rising up approaching high lunar tide, and there is no methane seeping into the atmosphere to diminish the normally strong resistance to electrical flow in the atmosphere.

## Patented Lightning Data Analysis shows strikes are tied to geology

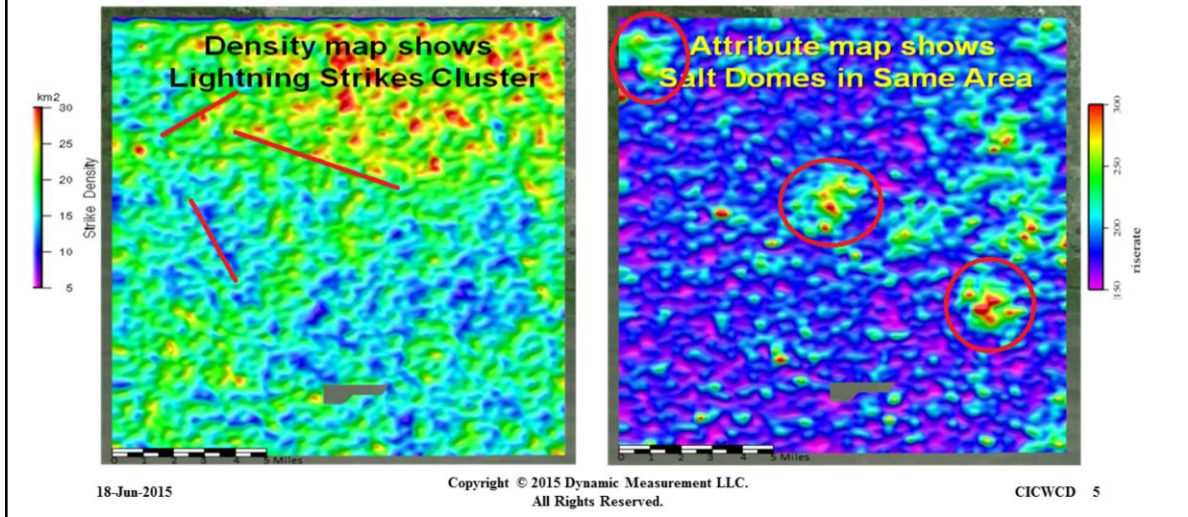

This example from Iberia Parish, Louisiana, shows examples of the map information which can be derived from lightning strike data. On the left is a lightning density map. There are clusters of lightning strikes, more onshore, and less in the swamps and bay. There are also lineaments which can be drawn on this data (3 red lines are drawn related to known faults), which are related to known faults, and shallow geologic features like ancient river meanders.

The slide on the right is rate-of-rise-time, one of hundreds of different lightning attribute maps derived from the lightning database. The three stronger areas (3 red circles) show the location of 3 large salt domes in this area. Working with all of the maps DML has demonstrated the ability to generate maps of shallow geology from the lightning database. DML has an exclusive license to use the lightning database for natural resource exploration, has one patent issued, and one patent pending protecting the intellectual property we have developed over the last 8 years.

## Relaxation Oscillator Physics (think Neon Signs)

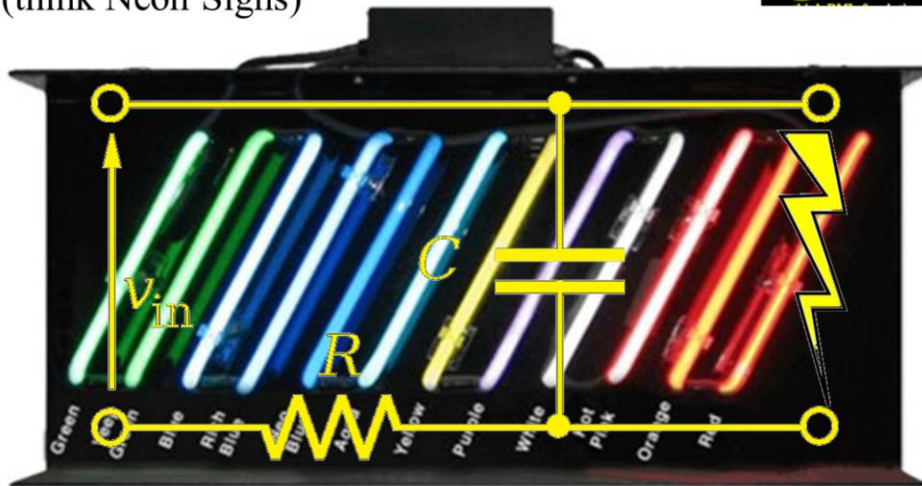

18-Jun-2015

Copyright © 2015 Dynamic Measurement LLC.  
All Rights Reserved.

CICWCD 6

Lightning strikes are a key component in the self-repairing natural capacitor which controls the earth's electrical system. Electrical energy from the sun is captured by the earth in the ionosphere. This electrical energy makes its way to the ground through the Aurora Borealis, the Aurora Australis, and through lightning strikes. The clouds form the upper plate of a capacitor. The ground forms the base plate of a capacitor. The physics defining energy jumping across this capacitor is well defined mathematically as a relaxation oscillator, or a neon light tube. Energy builds up on one side of the capacitor until it is sufficient to overcome the resistance in the neon light tube, and then there is a spark across the capacitor. Different types and combinations of noble gases in the vacuum tube create different colors when electricity sparks across the capacitor.

## Lightning bridges a Natural Capacitor

- The atmospheric capacitor is nearly the same physics
- Just an additional resistance ( $R_2$ ) limiting the current
- $R_2$  is the resistance between the lightning strike point and the bottom plate of the capacitor

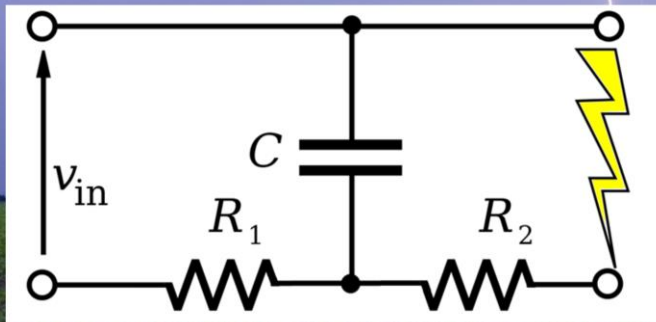

18-Jun-2015

Copyright © 2015 Dynamic Measurement LLC.  
All Rights Reserved.

CICWCD 7

Atmospheric capacitor physics is basically the same as a relaxation oscillator physics. We know how good of an insulator the atmosphere is because there are no sparks between wires along high tension power lines (unless you throw bailing wire across the lines, like Charlie Garfield and I did down by the Nelson Pond when we were in High School - that night, as we watched the lights in the valley go out, we found out the power for Enoch went through Dad's farm). The difference between lightning and a relaxation oscillator is there is an additional resistance,  $R_2$ , limiting the current. This is the resistance between the lightning strike point and the bottom plate of the capacitor. This bottom plate is a volume of earth disrupted by changes in geology, including faults, stratigraphy, lithology, and fluids. DML developed algorithms allowing calculations of rock property volumes. This works because the geology does not change. Every lightning storm is a new event, based on meteorological conditions. Since lightning strikes occur everywhere, the various storms paint the geology with electrical energy stored in lightning strike databases. There are over 17 years worth of lightning strike information in the NLDN database. In Louisiana, with 50+ lightning strikes per square kilometer per year, there are 850 lightning strikes per square kilometer in the database. In Pine Valley, Beaver County, Utah, with 0.5-1.0 lightning strikes per square kilometer per year, there are still 8-17 lightning strikes per square kilometer in the database. DML has developed ways to stack, or sum, these lightning strikes to derive surface and subsurface geologic information.

## Lightning Strike Measurements

- Location
- Time and Duration
- Rise Time
- Peak Current
- Polarity
- Peak-to-Zero
- Density

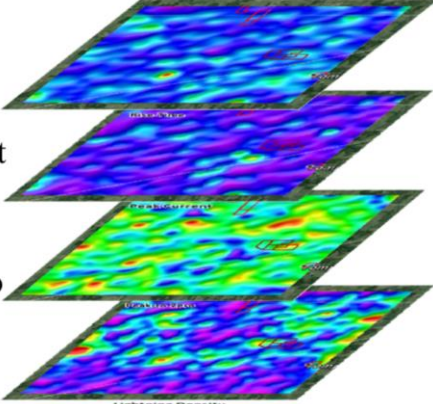
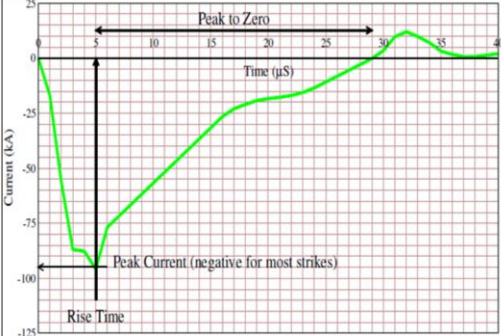

18-Jun-2015
Copyright © 2015 Dynamic Measurement LLC.  
All Rights Reserved.
CICWCD 8

The basic data in the NLDN database starts with the location of the lightning strike. This location has been demonstrated to be accurate within about 300 feet in longitude and latitude. The geologic lineaments, faults and boundaries – say at the edge of volcanic flows, derived from lightning attribute maps have been demonstrated to be accurate down to 30 feet spatially. This location information provides information to map lightning strike density. The time of each lightning strike is recorded with microsecond accuracy. This allows DML to do time-lapse analysis of geologic changes, like fluid movement close to the surface or within the calculated rock property volumes.

Each lightning strike has a unique waveform. This waveform is defined by the time it takes to go from background electrical noise to the peak current, which is known as the Rise-Time (measured in microseconds), by the Peak Current (measured in kilo-amps), and the time it takes to go from the peak current back to the background electrical noise, which is known as Peak-to-Zero (also measured in microseconds). Most lightning strikes are negative, although up to 20% of the lightning strikes can be positive. Numerous other lightning attributes can be derived from these (and other) basic measurements. For instance, Total Wavelet Time is the sum of Rise-Time and Peak-to-Zero and Wavelet Symmetry is the ratio. DML is documenting the geological significance of each of the different derived lightning attribute maps and rock property volumes.



## Topography and Lightning Density, Arizona

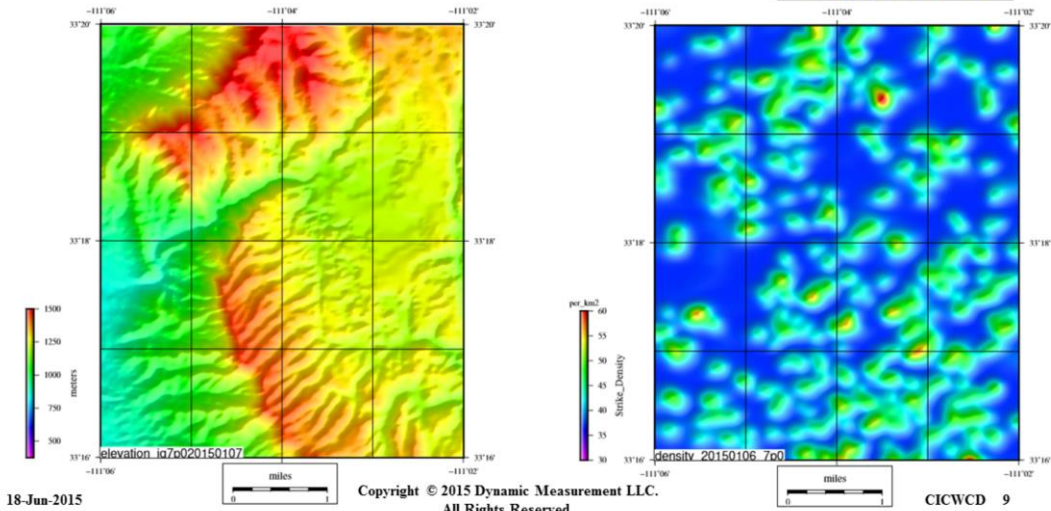

The lightning analysis DML did across the Resolution Copper Mine location near Superior, Arizona is an analog for how a lightning analysis in Pine Valley, Beaver County, Utah could optimize West Desert drilling locations. In both places there is considerable topography. The Arizona topography is shown on the map on the left (800-1500 meters or 2,500-5,000 feet). Note the lightning density map for this area, on the right, locates 35-60 lightning strikes per square kilometer per year. These lightning strikes do not cluster along the tops of the mountains. Rather, the location of the strikes is primarily tied to geologic considerations.

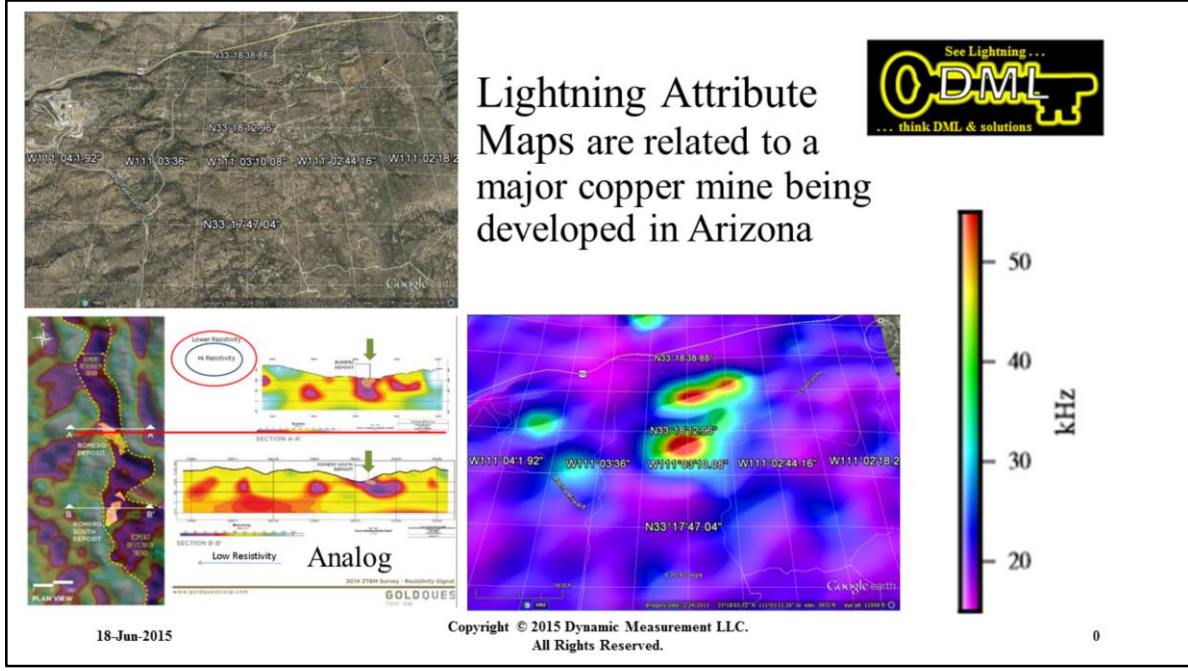

Due to time limitations, only two maps of lightning attributes which will be shown in this presentation. The upper left map is a satellite image of the area. The map and cross section is an analog example of a copper deposit shown in map and cross-section view. The lightning attribute map shown is frequency, which is calculated assuming the sum of Rise-Time and Peak-to-Zero Time (Total Wavelet Time) is one-half of a cycle. The anomaly is geological. I anticipated, between the hundreds of attribute maps DML generates in doing an analysis, we will be able to distinguish the lateral extent of volcanic flows and possibly map the sweet-spots or thickest highly resistive fresh water deposits (aquifers).

Geologists work with multiple working hypotheses. This is quite different from how engineers work, where specific measurements are required before taking action. Geologists also work with analogs, which have a tendency to place limits on possible multiple working hypotheses. Data further defines and sharpens boundaries, creating options which have a higher probability of success. Both geologists and engineers understand the importance of data in making decisions. When test wells in the West Desert cost upwards of \$200,000 each, it makes sense to optimally locate these wells. One test well drilled into volcanic flows, becomes a very expensive engineering test. Lightning analysis can optimize results and reduce test well location risks.

## Resolution Copper Mine Thermal-Halos interpreted from Lightning Data

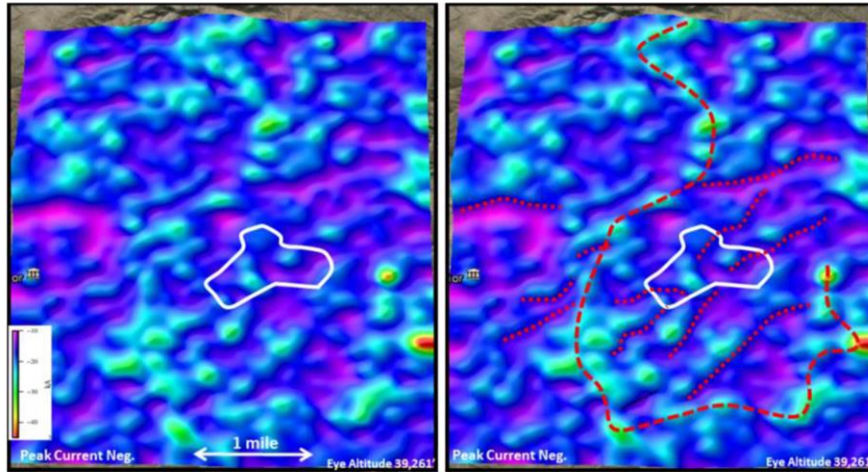

15-Jun-16

Copyright © 2015 Dynamic Measurement LLC.  
All Rights Reserved.

CICWCD 11

This lightning attribute map across the Resolution Copper Mine location shows the distribution of Negative Peak Current strikes over 15 years of lightning data collection. The location of the key copper porphyry deposit is shown with a white outline. The map on the left is raw data, with an interpretation overlain on a duplicate of this map on the right. An objective of these maps is to develop analog maps which can be used to look for other mining sites along a trend. This interpretation shows a possible pyrite thermal halo around the porphyry stock (longer red dashes), as well as possible linear volcanic sills (shorter red dashes), which are commonly associated with the creation of copper porphyry deposits. Other lightning attribute maps show trends related to other geological factors. A key part of each project is to define geological objectives up front, along with any surface geology or well control existing in the analysis area, which control can be used to tie down or normalize the interpretation of the various lightning attribute maps.

## Resistivity & Permittivity Volumes Resolution Copper Mine, Arizona

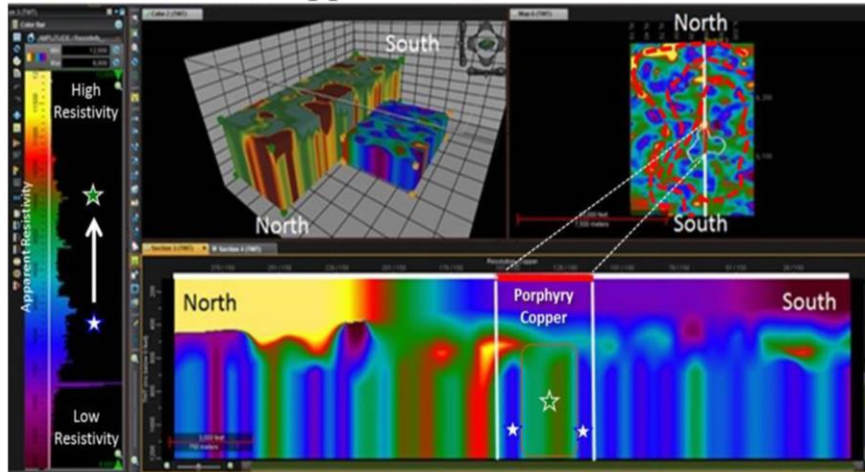

15-Jun-22

Copyright © 2015 Dynamic Measurement LLC.  
All Rights Reserved.

CICWCD 12

DML technology includes the ability to create rock property volumes. This includes creation of resistivity and permittivity volumes. The cross-section (bottom), horizontal slice (upper right), and smaller cube probe with the same colors (upper left) are displays from a resistivity volume. The larger cube probe (upper left) is from a permittivity volume - data similar to that collected with an IP (Instantaneous Potential) geophysical survey. Thermal halos are interpreted on the horizontal-slice, with the porphyry extent marked on the north-south cross-section. Assumptions tied to creating rock property volumes include: (1) the depth of electrical currents controlling lightning strike locations is tied to the length of the lightning stroke; (2) this length is related to the energy needed to bridge the atmospheric dielectric capacitance; and (3) this length is tied to the Peak Current. Since there are no lightning strokes from clouds lower than 800-1500 feet, there is no data in the shallower portions of the rock property volumes. Since there are not many lightning strikes traveling more than 20,000 feet, there are not many good data points at depth. The sweet zone, in the Arizona Resolution Copper data set, is from 360-720 milliseconds two-way travel time (or assuming 12,000 feet per second, from 2,000-4,500 feet depth). Using the same assumptions, another desert area has a sweet zone from 1,000-3,500 ms, or 6,000 to 21,000 feet. Vertical calibration is something DML is improving. The displays are made with DecisionSpace<sup>®</sup>, an interpretation product of Landmark Graphics Corp., a company I co-founded in 1982.

## Michigan Basin Topography & Strike Density

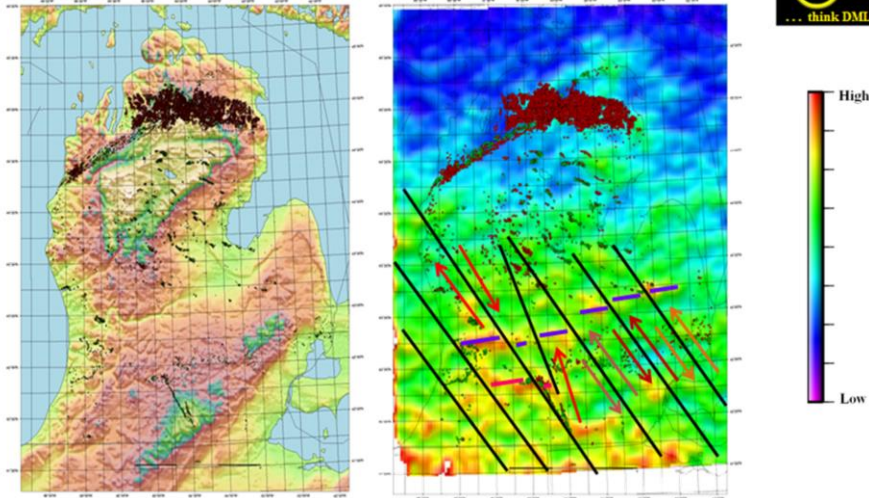

18-Jun-2015

Copyright © 2015 Dynamic Measurement LLC.  
All Rights Reserved.

CICWCD 13

A key advantage of using lightning data as a geophysical analysis tool is scale. Areas from a square mile to a subdivision to a county to a state or to a country can be evaluated with data already collected. There is no permitting required to collect data, as it is already in the database. The analysis results tell us more about the geology of an area. This example covers the Michigan peninsula. The map on the left is topography, and the map on the right is lightning density. Both maps have gas wells (red) and oil wells (green) overlaid. There is a large circle of existing wells, which shows the extent of the pinnacle reefs which grew around the edge of the basin during Paleozoic Geologic Era (250-500 million years ago). Note the straight line of wells in the bottom center of the topography map. This is the Albion-Scipio Field, one of the larger oil fields in the U.S. This field was formed by hydrothermal alteration along a large strike-slip fault. There is another field that branches to the right from the south end of the Albion-Scipio field, which is the Stony Point Field. Looking at the lightning density map, regional trends were identified along these fields, and extended as a series of parallel strike-slip faults. When shown to a geophysicist who had worked this area for decades, he said this was the first map he has seen identifying the possible location of these faults. These strike-slip faults can not be seen on seismic nor interpreted from well logs. Lightning databases provide a new way to evaluate the geology of any area.

## Michigan Limestone Reefs & Resistivity Volumes



15-Jun-16

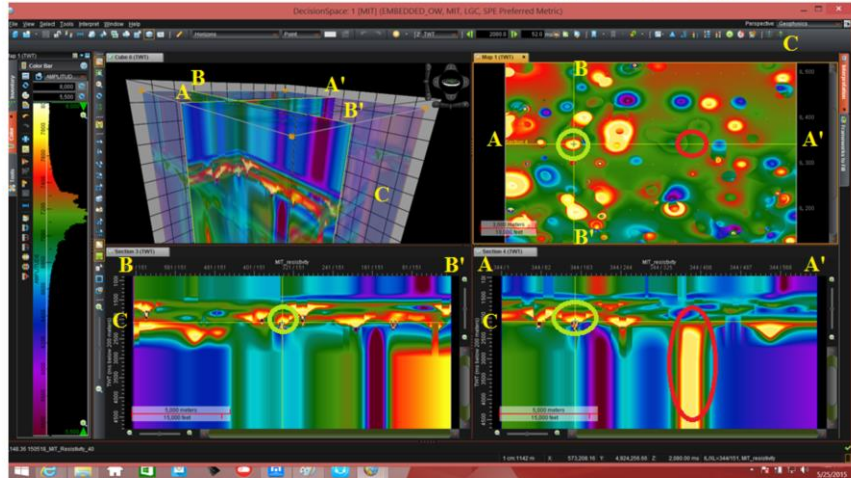

Copyright © 2015 Dynamic Measurement LLC.  
All Rights Reserved.

CICWCD 14

A more detailed analysis was recently done over a small 100 square mile area at the northwest side of the peninsula (yellow box on map on the left) where a lot of pinnacle reefs are known to exist. The maps on the right are from a resistivity volume calculated from a lightning analysis over this area. There is a semi-transparent resistivity cube in the upper left corner, with an in-line (A-A'), a cross-line (B-B'), and a horizontal-slice (C) sections highlighted. The section on the bottom right has a large resistivity anomaly going to depth, which we interpret as a pinnacle reef (red circle). Pinnacle Reefs are limestone build-ups which can be several hundred feet high. Both sections on the bottom had a series of resistivity anomalies, which are interpreted as bioherm reefs (lime circle). Bioherm reefs are shallow water reefs buried under sediments which have eroded from the surrounding areas. The main point being demonstrated here is that lightning rock property volumes tie to specific rock properties.

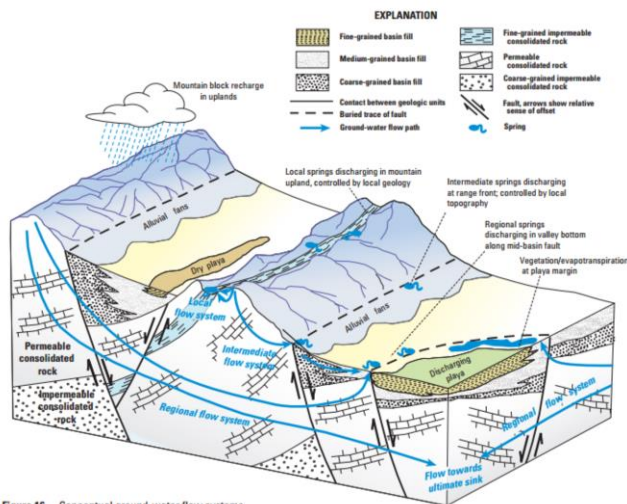

Figure 16. Conceptual ground-water flow systems.

Water Resources of the Basin and Range Carbonate-Rock Aquifer System, White Pine County, Nevada, and Adjacent Areas in Nevada and Utah—Draft Report USGS

18-Jun-2015

Copyright © 2015 Dynamic Measurement LLC. All Rights Reserved.

CICWCD 15

## Carbonate Aquifers in Pine Valley & Wah Wah Valley

Understanding similar rock property distributions in Pine Valley and Wah Wah Valley could be critical to optimizing the location of test wells. The CICWCD will want to avoid the existing deep seated carbonate aquifers, which the USGS has published articles about, as shown above. There will also be a need to avoid volcanic flows. Alluvial sediments at the edge of basin, the gray areas against the faults shown above, are the best potential aquifers. Between lightning attribute maps and rock property volumes, a new geological interpretation of the two basins could be developed using lightning analysis techniques. The USGS, the BLM, the Utah State Geological Survey, the Division of Water Rights, or companies which are interested in developing calibrated geologic models might be interested in funding a lightning analysis project in this area. It is possible this analysis will show the flow of resistive fresh water as it migrates through the basin. This type of information can be of tremendous value in this area, as well as in other areas where these funding groups have a strong public or economic incentive to understand geology, structure, stratigraphy, lithology, and fluid distributions, as well as fluid migration pathways.

# Iron County: lower than normal hydrostatic pressure

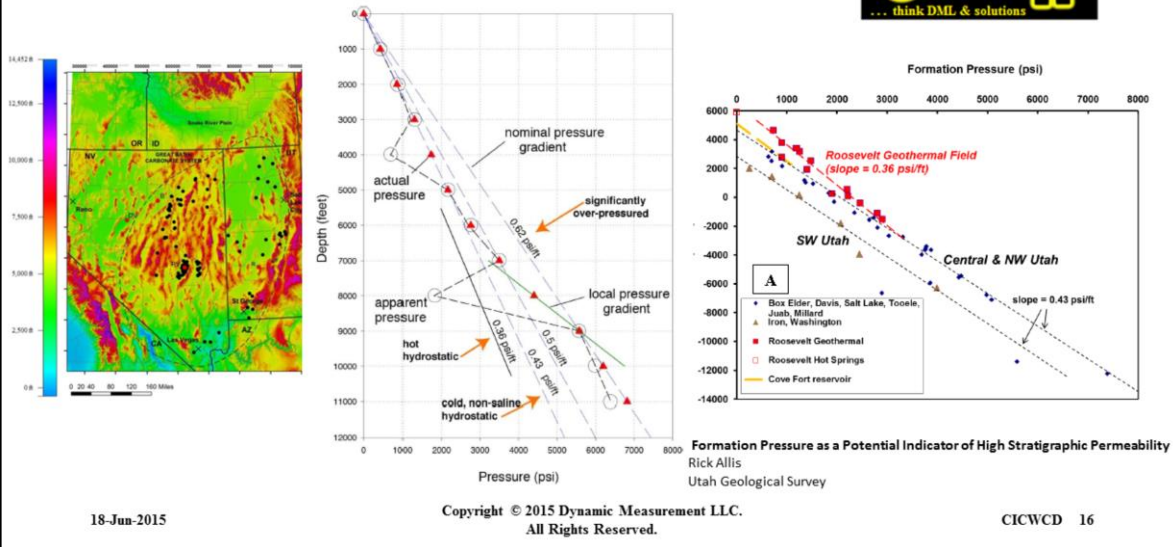

For instance, we have talked about the fact wells in the southern part of the Great Basin are less than normal hydrostatic pressure. Hydrostatic pressure is the pressure exerted by a fluid at equilibrium at a given point within that fluid due to the force of gravity. Hydrostatic pressure normally increases in proportion to the depth measured from the surface, specifically because of the increasing weight of fluid exerting downward force from above. A tank on a higher hill has more pressure than a tank on a lower hill. After all, water flows downhill. However, if a tank starts to leak when a certain pressure is reached, the leak limits the build-up of hydrostatic pressure. The southern Great Basin is like a leaky water tank. The map above shows the location of wells in this study by the Utah Geological Survey. The graph in the middle shows how hydrostatic pressure can vary for geothermal wells, normal wells, and wells overpressured by oil and gas deposits, which hydrocarbon deposits strive to move upward because they are lighter than water. The graph on the right shows hydrostatic pressure measurements for several places in Utah. Notice the bottom straight line (dipping down to the right) is the hydrostatic pressure through wells in Southern Utah. This curve is shifted to the left because water is leaking out of the basin. The result is pressure is either building up in basins to the southwest of Cedar, or is flowing out into the Grand Canyon. To be specific, a well at 2,000 feet depth in southwest Utah has hydrostatic pressure of 2,000 psi. Wells elsewhere in Utah, at 2,000 foot depth, have hydrostatic pressure of closer to 3,000 psi.



# Faults Draining to Grand Canyon Lower Hydrostatic Pressure

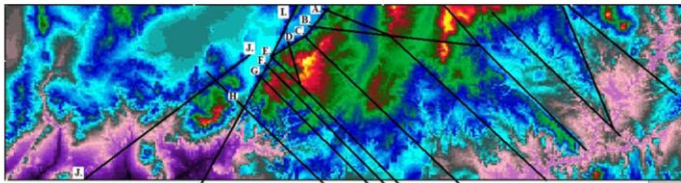

- A. Paragonah Canyon
- B. Parowan Canyon
- C. Summit Canyon
- D. Fiddlers Canyon
- E. Cedar Canyon
- F. Kararaville Canyon

- G. Five Fingers
- H. New Harmony
- I. Hurricane Fault
- J. Pinevalley

Possible Fault Geopressure Leak Pathways  
from Cedar Valley to the Colorado River

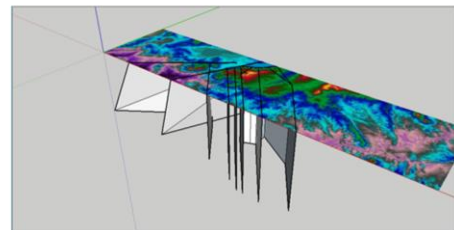
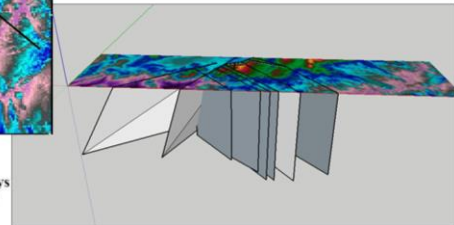
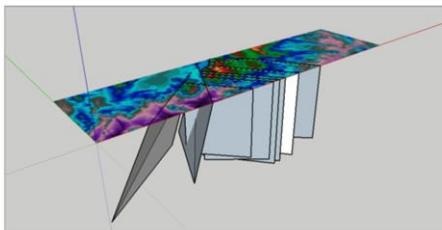

18-Jun-2015

Copyright © 2015 Dynamic Measurement LLC.  
All Rights Reserved.

CICWCD 17

This map, generated for Eldon Schmutz when he was running the CICWCD, shows a possible interpretation of the leak points for the southern Great Basin. The three other images are 3-D rotations of a geologic model showing a simplified distribution of these faults at depth with different rotational views. On the bottom left you are looking down along the Hurricane Fault. This is rotated in the upper right, and rotated in the bottom right so you are looking along a series of probable strike-slip faults going down to the Grand Canyon. While this does not impact the planned shallow wells in the West Desert, it is good justification for going after this water before it sinks sufficiently to reach the underground slow moving rivers which form along these faults.

## Upward Lightning tied to geology



<http://www.walden3d.com/IronCounty>

<http://www.walden3d.com/IronCounty/CedarValleyWater>

18-Jun-2015

Copyright © 2015 Dynamic Measurement LLC.  
All Rights Reserved.

CICWCD 18

Again, lightning analysis is a new geophysical data type which allows building of a better geologic model than can be developed from projecting surface geology downward. The lightning strike image above shows an up-going lightning strike, which only can occur because of electrical currents built up in subsurface geology. The top link, <http://www.walden3d.com/IronCounty>, is to some web pages I have been putting together as a prototype for Iron County and for the CICWCD to consider using for better distributing information to stakeholders. The bottom link, <http://www.walden3d.com/IronCounty/CedarValleyWater>, goes to presentations which I put together for the CICWCD starting on September 19<sup>th</sup>, 2005, or which are presentations or articles about the CICWCD which I think are important to share with others.

## Quartz Monzonite Aquifer to the West



## Cretaceous Aquifer to the East

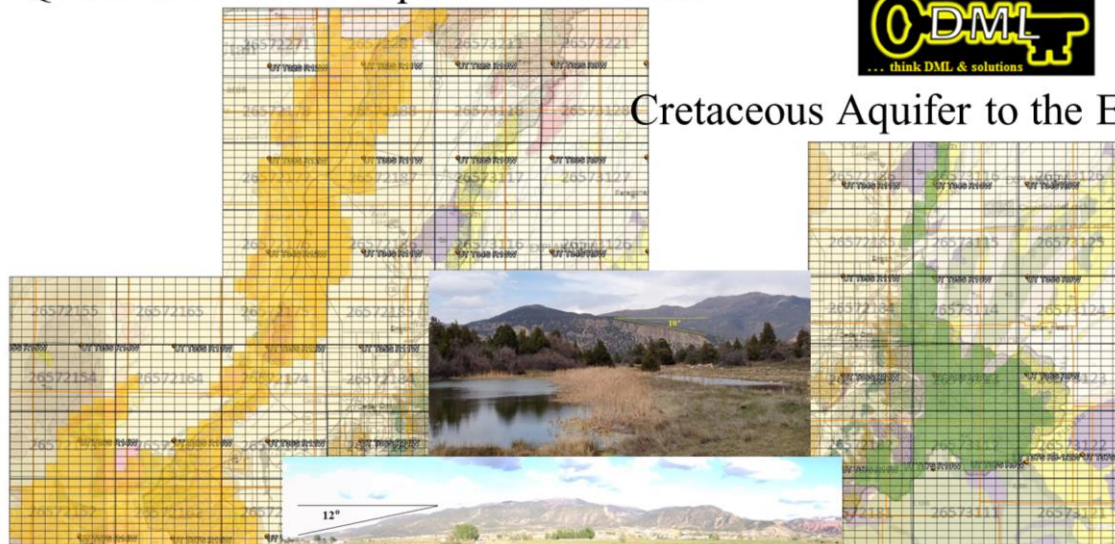

15-Jun-22

Copyright © 2015 Dynamic Measurement LLC.  
All Rights Reserved.

CICWCD 19

This slide is a composite of maps from the first web site, <http://www.walden3d.com/IronCounty>. It shows of the extent of the mostly untapped Quartz Monzonite Aquifer to the west of Cedar City, as well as the extent of the mostly untapped Cretaceous Aquifer to the east of Cedar City. The Quartz Monzonite Aquifer has been tapped down next to Pine Valley Mountain (not Pine Valley, Beaver County), near New Harmony. These New Harmony wells show the anticipated water production which will accompany opening up the Arco #1 well at Iron Springs and testing water production from the Quartz Monzonite. The Cretaceous Aquifer, which dips to the east as shown on the photograph from up Right Hand Canyon, and which dips more to the north, as shown on the photograph from out by Brent Hunter's place, has been tested by the recent well at Brian Head. Gary Player and I feel this aquifer needs to be tested at Woods Ranch, then up Ashdown Gorge (possibly on SUU or Bauer property surrounded by Dixie National Forrest), and then up above the location of the ongoing landslides by the old coal mine.

# Cretaceous Aquifer east of Cedar City

Straight Cliffs Formation over Dakota Formation, north of Highway 14 at Mile 8, east of Cedar City.

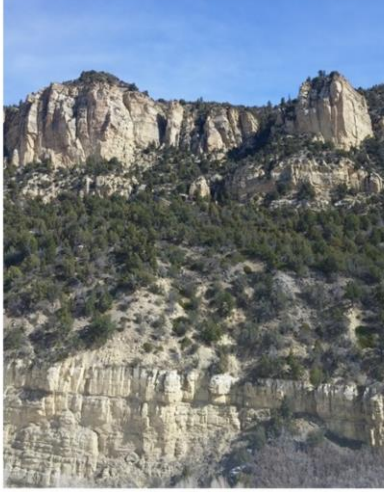

Photo by Gary F. Player, Utah Professional Geologist 5280804-2250, March 14, 2015

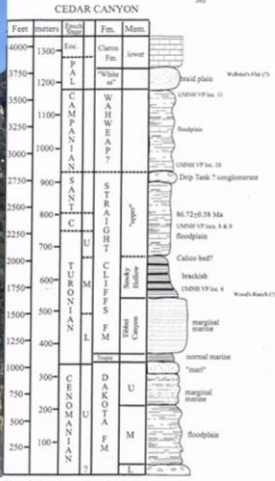
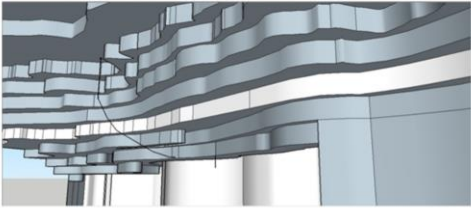
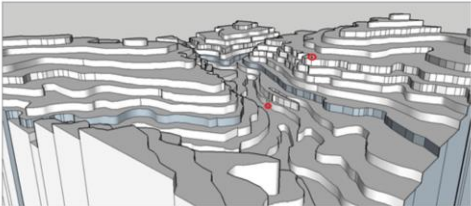

Figure 4. Comparison of Upper Cretaceous and lower Tertiary stratigraphy in Cedar and Panguitch Canyons. The Panguitch section is being on the contact between the Clinch and Grand Canyon Formations.



15-Jun-22

Copyright © 2015 Dynamic Measurement LLC. All Rights Reserved.

CICWCD 20

These three images are also from the first web site, <http://www.walden3d.com/IronCounty>. The image on the left is looking up at the Straight Cliffs and the Dakota from Coal Creek just west of where the landslides have occurred. This image nicely correlates with the geologic type log in the center of the page. The two views to the right are views of a model of Cedar Canyon showing a well drilled from the old road up Cedar Canyon, deviating down and emptying into Coal Creek. This type of deviated well would allow production of water with no pumping costs. If generators were placed in the well bore, it would also allow the generation of electricity as water is dumped into Coal Creek. This would be a source of water and power year round, with little to no maintenance. True conservancy.

# Lightning Analysis Price

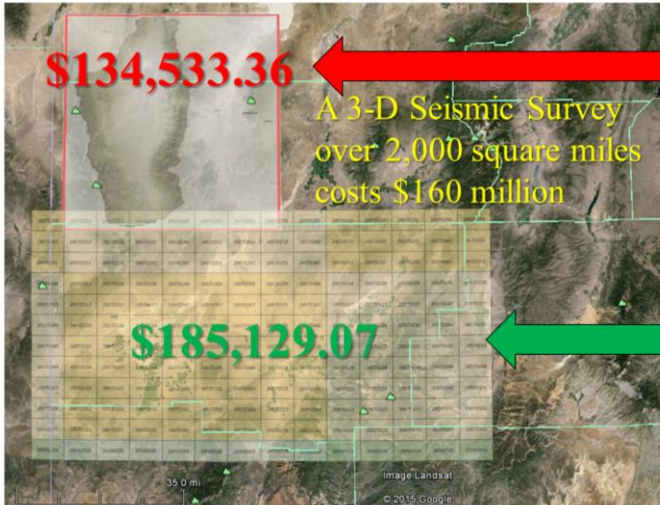

A 3-D Seismic Survey over 2,000 square miles costs \$160 million

**\$134,533.36**

**\$185,129.07**

## DML Decimal Longitude & Latitude Calculator

DML Area Calculator from Longitude & Latitude Input	
Data Entry Red Cells (Decimal Longitude & Latitude), Calculations/Parameters Yellow Cells, Results Green Cells	
WW Center Longitude: 108.755	W (km) 71.522296 Radius: 6371444.5
WW Center Latitude: -113.241553	E (km) 82.889396 MPZ: 0.3040000
NE Center Longitude: -113.241553	N (km) 70.749390 FZM: 5.262
NE Center Latitude: -108.755	S (km) 71.884490 Area (sq km): 5084.194260
SW Center Longitude: -114	W (mi) 44.210075
SW Center Latitude: 108.755	E (mi) 44.210075
SE Center Longitude: -113.939193	N (mi) 43.965884
SE Center Latitude: 108.755193	S (mi) 44.738162 Area (sq mi): 1956.819187

DML Lightning Analysis Project Price Calculator	
Enter Area (sq. km.): 5.088	Enter Area (sq. mi.): 1.967
Enter Area (acres): 1,253,373.67	Price (BUS): \$134,533.36

Confidential to Dynamic Measurement LLC Copyright © 2014 DML

## DML Decimal Longitude & Latitude Calculator

DML Area Calculator from Longitude & Latitude Input	
Data Entry Red Cells (Decimal Longitude & Latitude), Calculations/Parameters Yellow Cells, Results Green Cells	
WW Center Longitude: 108.755	W (km) 82.889396 Radius: 6371444.5
WW Center Latitude: -113.241553	E (km) 82.889396 MPZ: 0.3040000
NE Center Longitude: -113.241553	N (km) 152.881368 FZM: 5.262
NE Center Latitude: -108.755	S (km) 154.118168 Area (sq km): 11794.00990
SW Center Longitude: -114.215	W (mi) 51.502240
SW Center Latitude: 107.4431667	E (mi) 51.502240
SE Center Longitude: -112.476	N (mi) 46.981847
SE Center Latitude: 107.4431667	S (mi) 95.963701 Area (sq mi): 4916.801972

DML Lightning Analysis Project Price Calculator	
Enter Area (sq. km.): 12.726	Enter Area (sq. mi.): 4.907
Enter Area (acres): 3,146,753.28	Price (BUS): \$185,129.07

Confidential to Dynamic Measurement LLC Copyright © 2014 DML

18-Jun-2015

Copyright © 2015 Dynamic Measurement LLC. All Rights Reserved.

CICWCD 21

DML has committed to doing a lightning analysis over Iron County. At DML's current pricing, this is a \$185,129 project. Justification is I live here, and I can field test results. DML wants to understand topography impacts, to test response from a known iron mine deposit, to see how well we can map and predict the extent of fresh water aquifers, to look at lightning clusters relative to dead trees - predicting risk of lightning strike clusters starting forest fires, to test these as a base framework information layer for county planning, etc. Given success, DML will to market result to others. The Pine Valley / Wah Wah Valley Analysis is smaller, \$135,533. There are not the same marketing advantages, and - being in start-up mode - it does not make sense to offer this as a free analysis. A 3-D seismic survey, the most comprehensive way to study the geology of the subsurface, costs about \$80,000 per square mile, so a 3-D survey over the 2,000 square miles covering the West Valleys costs ~\$160 million. The cost of a lightning analysis is less than 0.1% the cost of a 3-D seismic survey over this same area. DML is glad to make presentations for and with the CIWCD to groups who might be interested in funding a lightning analysis project. A \$134,533 lightning analysis is less than the cost of one of the planned west valley test wells, and this analysis will optimize all wells drilled in Pine Valley and Wah Wah Valley.

## Technical Merit & Economic Benefits

- Maps, Sections, and Volumes
- Evergreen Data
- 17 year database US & Canada
- Integrates with other data
- Simple Solution
- Patented, & Patent Pending
  
- 2 month project turnaround
- Larger Area – Less Expense compared to other geophysical tools
- **Provides a scientific basis for the location of west desert test wells**

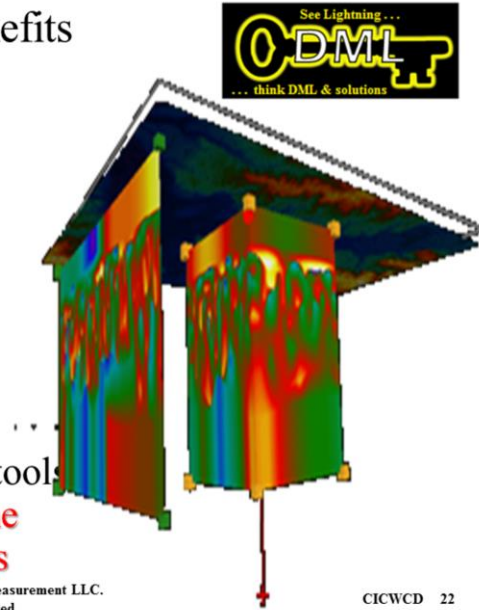

18-Jun-2015

Copyright © 2015 Dynamic Measurement LLC.  
All Rights Reserved.

CICWCD 22

In summary, lightning analysis provides a way to create maps, sections and volumes across an area using evergreen, always being updated, lightning databases. DML has an exclusive license to a 17 year database of lightning data in the U.S. This data integrates well with other data, and is a simple solution. The basic exploration processes are protected by an existing U.S. Patent, and there is one patent pending and two other patents about to be submitted protecting the trade secrets DML has developed over the last 8 years. It only takes 2 months to complete a lightning analysis project. These projects cover larger areas and are less expensive than other geophysical approaches. Of specific importance to the CICWCD, this analysis will provide a scientific basis for the location of the west desert test wells.

See Lightning, Think DML



• Contact Information:

• H. Roice Nelson, Jr.

cell: 713.542.2207

e-mail: [roice@dynamicmeasurement.com](mailto:roice@dynamicmeasurement.com)

▪ [www.dynamicmeasurement.com](http://www.dynamicmeasurement.com)

▪ 2155 West 700 South #31

Cedar City, UT 84720

Fax: 435.267.2668

• Dr. Jim Siebert

cell: 832.423.2355

e-mail: [jim@dynamicmeasurement.com](mailto:jim@dynamicmeasurement.com)

▪ 211 Baker Road #382

Barker, TX 77413

Office: 281.579.0172

[http://www.walden3d.com/IronCounty/CedarValleyWater/150618\\_CICWCD\\_Presentation.pdf](http://www.walden3d.com/IronCounty/CedarValleyWater/150618_CICWCD_Presentation.pdf)

18-Jun-2015

Copyright © 2015 Dynamic Measurement LLC.  
All Rights Reserved.

CICWCD 23

I am here in Cedar City in The Seasons on Leigh Hill. I work out of my home, and am glad to demonstrate DML technologies and to go into more detail for anyone interested and associated with the CICWCD. Most of the DML team is located in West Houston, and can be contacted at the Barker, Texas address. Thank you for your time and attention. I look forward to working with the CICWCD for the rest of my life. This presentation can be downloaded from

[http://www.walden3d.com/IronCounty/CedarValleyWater/150618\\_CICWCD\\_Presentation.pdf](http://www.walden3d.com/IronCounty/CedarValleyWater/150618_CICWCD_Presentation.pdf).